

# MultiTransmit parallel RF transmission technology

## Setting the benchmark in clinical high-field imaging

Paul R. Harvey, PhD.

Romhild M. Hoogeveen, PhD

To fundamentally overcome the challenges of 3T and to drive the adoption of 3T as a mainstream system for all applications, an extensive development program within Philips has led to next generation technology, called MultiTransmit parallel RF transmission [16, 17]. This technology is now available with the Achieva 3.0T TX.

From the beginning of 3.0T developments within Philips, the clinical value of high-field imaging has always been a driver in choosing the right technologies. With clear benefits of imaging at 3.0T (higher SNR and sensitivity for higher speed and resolution), the challenge has always been to optimize clinical utility whilst mastering fundamental high-field challenges. Unlike 1.5T, the most important fundamental challenges at 3.0T have been controlling SAR and the dielectric effect [30].

The first steps in addressing these challenges were made by the advanced technological developments embodied in the Achieva X-series. The X-series has led 3.0T technology since its introduction in 2006 [34], as evidenced by the many hundreds of installations being used clinically around the world. X-series technology includes a patient-friendly, compact magnet with powerful gradients and optimized RF with a unique, short RF body coil to reduce SAR and dielectric effects. Other technologies introduced to minimize SAR and dielectric effects include SENSE parallel imaging,  $B_1$  control, flip angle sweep, SPAIR and body tuned CLEAR (RF-SMART) [34]. These developments have resulted in widespread use of clinical 3.0T systems, with clear advantages in areas such as neuro [1, 2, 3], musculoskeletal [4], pelvic [5] and angiographic imaging [6, 7].

Nevertheless, 3.0T systems still pose challenges in terms of RF uniformity [8, 9] and SAR [10, 11, 12]. Recent studies have shown that the presence of dielectric shading can still impact clinical applications, leading, for example, to reduced signal in the liver [13] as well as left-right differences hampering diagnoses in breast imaging [14, 15].

To fundamentally overcome the challenges of 3.0T and to drive the adoption of 3.0T as a mainstream system for all applications, an enhanced technology has been realized: MultiTransmit parallel RF transmission. A number of topics are treated here in order to clarify the advantages of MultiTransmit. In this paper we will answer the following questions:

- What is MultiTransmit parallel RF transmission?
- How does it work?
- Why are patient-adaptive RF and multiple independent RF sources needed?
- What other approaches to RF shimming are there and are they equally effective?
- What are the benefits of MultiTransmit?
- Why is faster imaging possible with MultiTransmit?
- How many independent RF sources are really needed in parallel RF transmission?
- What is the history of MultiTransmit?

# MultiTransmit parallel RF transmission and its benefits

## Introduction

As MRI has moved to higher field strengths, the RF frequency for proton MRI has also increased. Partly due to the electrical properties of the human body and partly due to the physical scale, the RF excitation uniformity obtainable using a single channel volume transmit coil is sometimes not adequate for reliable clinical diagnosis in some applications and with some patients [13, 14, 15]. For the typical clinical systems used today, whole-body electromagnetic (EM) field simulations indicate significant RF non-uniformity (dielectric shading) and local SAR variations, which ultimately limit scan speed [10, 11, 12, 18].

## Multi-channel parallel RF transmission

Multi-channel RF transmission (MultiTransmit), using multiple RF transmit/receive chains and coil elements in parallel, has demonstrated that it is possible to significantly improve RF ( $B_1$  field) uniformity in high-field MRI [16, 40]. The additional degrees of freedom provided by multiple transmit channels/coils enable RF shimming while also minimizing local SAR [19, 27, 40]. It follows that multi-channel RF transmission is the enabler to obtain the maximum benefit from high-field MRI and opens the route to new imaging methods and applications [20, 21].

RF amplifier	An amplifier converts a low level RF demand signal to a high power level.
RF source	The combination of independent input signal and RF amplifier.
RF channel	Number of connections to the RF coil. Note: this may be higher in number than the number of RF sources (Figure 6).
Coil element	An arrangement of electrical conductors for converting an electrical current into a magnetic field.
RF coil	A combination of coil elements arranged to produce an advantageous $B_1$ field distribution.
Port	The point in an RF coil at which RF power is supplied
Degrees of freedom	The number of independent parameters needed to describe/control the full response of a system.

Table 1: Some definitions

## Single-source transmission – the classical integrated body coil

In most conventional single RF source MRI systems, the RF excitation field ( $B_1$ ) is provided by an integrated body coil driven in a fixed quadrature manner. Figure 1 shows such an arrangement. A single RF power source is split using a quadrature hybrid, and the integrated body coil is driven at two ports located 90 degrees apart [39]. The hybrid power splitter also serves to delay the phase of the signal to one of the driving ports by 90 degrees, thereby generating in an empty coil a circularly polarized RF field. This is often referred to as quadrature drive.

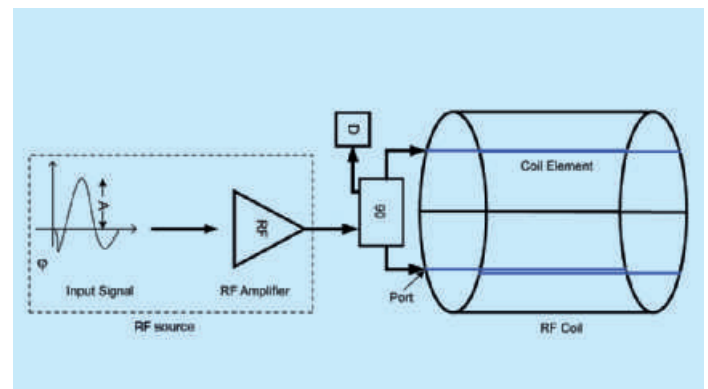

Figure 1 Quadrature drive integrated system body coil.

## Parallel RF transmission: transmission with multiple RF sources

### How does it work?

In recent years it has been recognized that there are advantages in departing from RF excitation using a fixed quadrature drive [16, 17, 19, 20, 21]. Figure 2 shows the example of a volume coil consisting of 8 independent elements driven by 8 independent RF sources. With such an arrangement, it is also possible to generate a circularly polarized  $B_1$  field. However, as described above, quadrature drive is not optimum for best RF uniformity at high field. Independent parallel sources enable the RF coil to be driven in ways which depart from pure quadrature and are thus able to compensate the RF field non-uniformity inside the body of the subject.

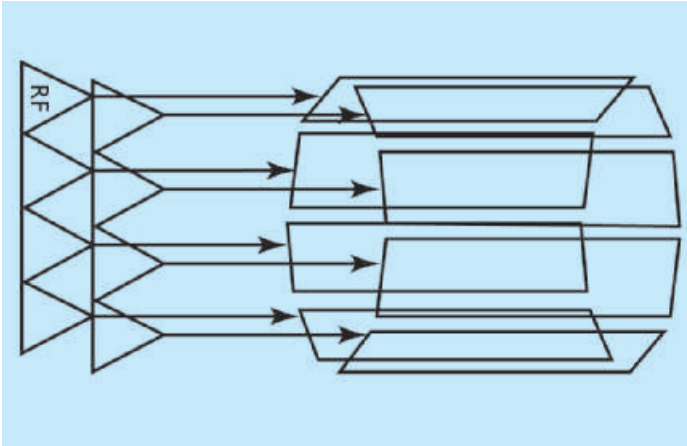

Figure 2 Generalized MultiTransmit array coil.

### RF shimming

The individual drive characteristics (e.g. waveform, power, amplitude, phase) for each of the RF sources can be obtained by mapping the  $B_1$  field inside the subject produced by each of the independent RF sources. The actual  $B_1$  field inside the subject can be treated as a linear

combination of the  $B_1$  fields generated by each source. Driving all sources in parallel using characteristics determined per patient results in a significantly more uniform  $B_1$  field inside the subject. The process of obtaining the coefficients with which to drive each of the RF sources, and applying these coefficients during parallel excitation, is known as RF shimming. Due to the reciprocity principle, RF shimming can also be used during MR signal reception.

### Parallel RF transmission using the system integrated body coil

The standard integrated body coil has two independent degrees of freedom. In effect it consists of two independent volume coil elements located 90 degrees apart. It is well known that in such a geometrical arrangement, these two independent modes can be treated as independent RF coils [22]. Figure 3 shows an arrangement in which two independent RF sources are connected to the independent modes of a standard integrated body coil, thereby realizing a dual-source MultiTransmit RF system. Our own internal studies and those of other researchers have demonstrated that this kind of arrangement, when used with a suitable level of control, significantly improves  $B_1$  uniformity in all relevant clinical applications [9, 17, 23].

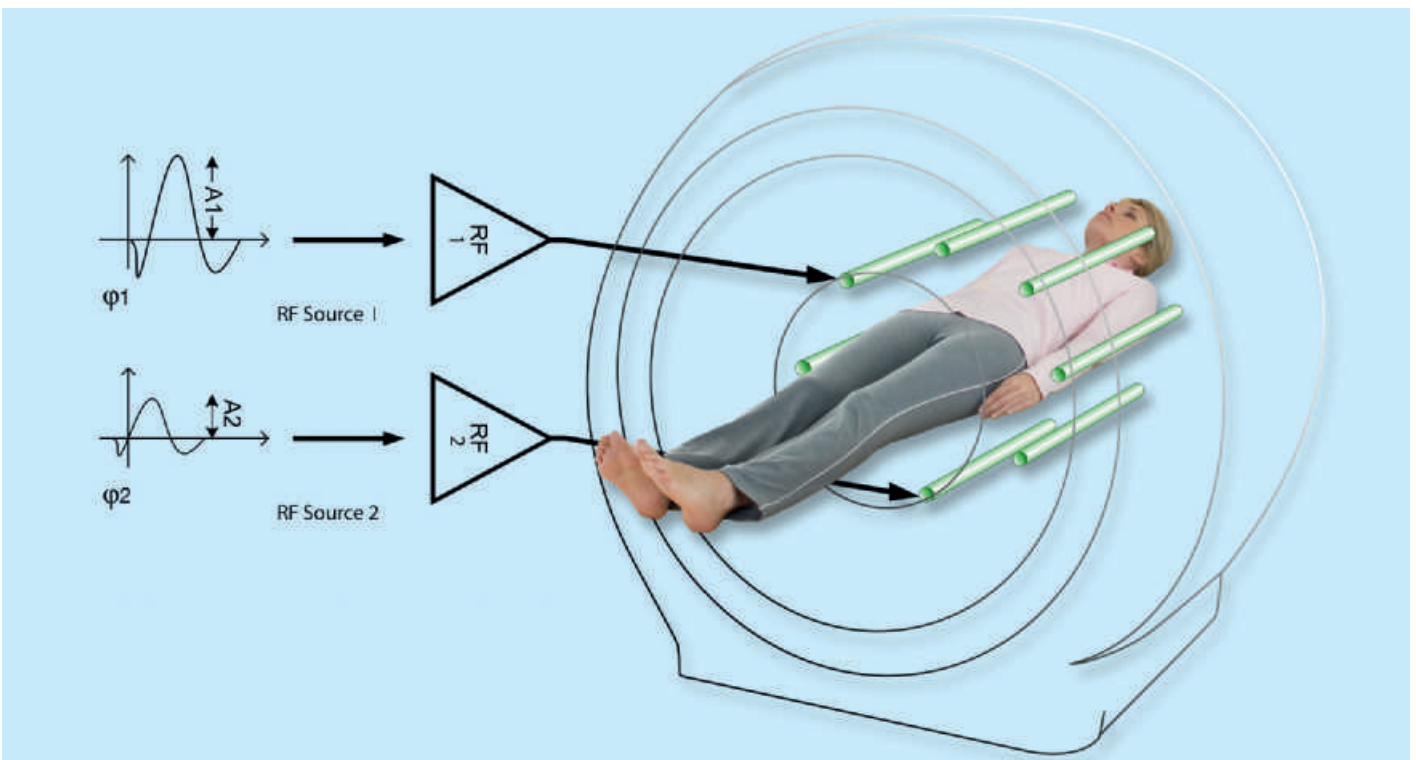

Figure 3 MultiTransmit integrated body coil with independent RF sources and parallel RF transmission.

### Why are patient-adaptive RF and multiple independent RF sources needed?

Some studies have proposed using fixed RF shim settings according to patient anatomy [9, 15, 23]. However, we have found this approach to be unreliable. The size and positioning of different patients in the MRI system strongly influence the RF shimming coefficients required to obtain the most uniform  $B_1$  field inside each subject. It is therefore necessary to adjust the RF shim coefficients per patient. The Achieva 3.0 TX achieves this by performing an in-vivo calibration to determine the required shim parameters.

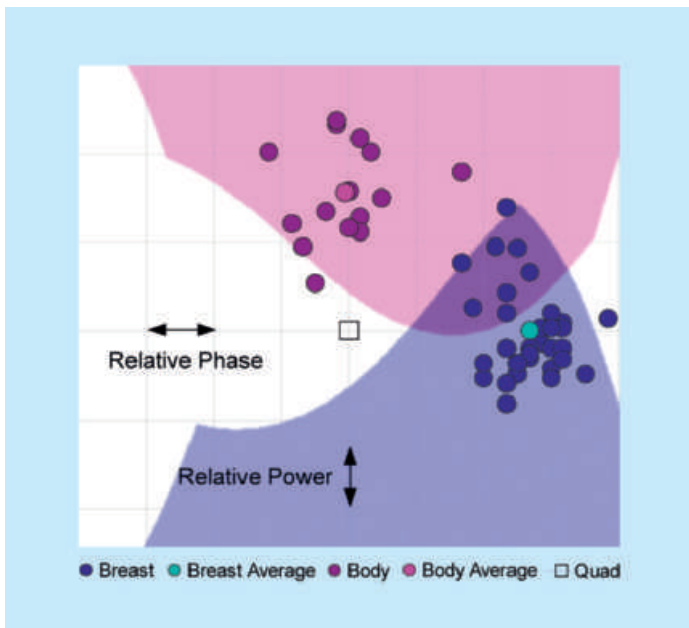
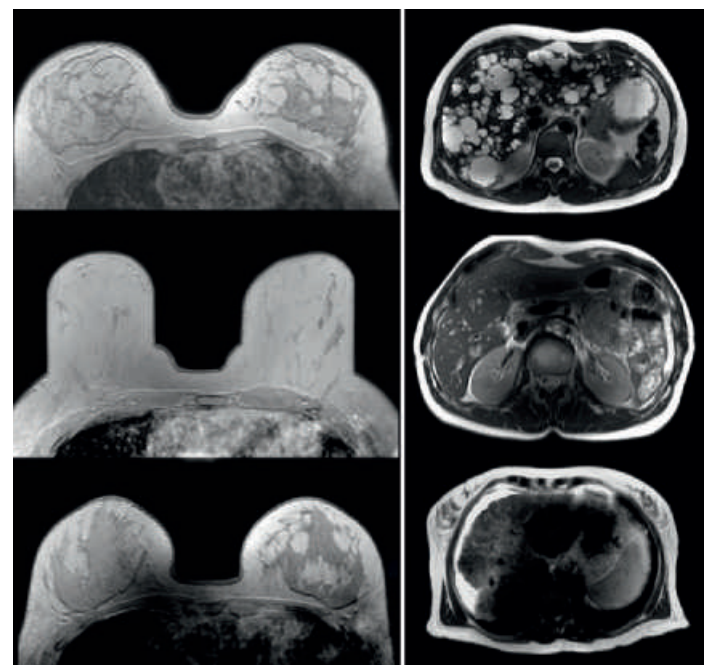

Figure 4 Patient-adaptive shimming - typical distribution of RF shim settings.

Figure 4 shows the distribution of RF shim settings, using the MultiTransmit arrangement described in Figure 3, for optimum  $B_1$  uniformity in a number of human subjects and two different anatomies. The horizontal axis represents relative phase deviation from quadrature and the vertical axis the relative power deviation from quadrature for the two independent transmit sources. The central square ( $\square$ ) corresponds to the RF settings for quadrature transmission. The expected shim settings that provide optimum uniformity for each anatomy were established using electromagnetic field (EM) simulations (HFSS, Ansoft, USA) and a stylized body model. The colored regions represent the range of shim settings for which a reasonable uniformity improvement is expected while maintaining practical power sensitivity. The colored circles represent shim settings obtained from the human subjects.

The results indicate that different anatomies require different shim settings. The spread between patients is so large that a fixed setting approach would lead to non-optimal shimming in a number of patients.

This is further illustrated in Figure 5, in which fixed RF settings have been used for every patient in breast and liver imaging. The example shows that while fixed RF settings may work in some patients (upper rows), it can lead to non-uniform RF behavior in other patients (middle, lower row). For optimal RF uniformity, patient-adaptive RF shim settings are needed.



Conventional 3T: breast

Conventional 3T: liver

Figure 5 Variability of results in conventional 3T for breast (left) and liver (right) imaging using fixed RF settings.

### Conclusion 1

Patient-adaptive RF shim settings using independent transmit sources are needed for optimal RF uniformity.

## What other approaches to RF shimming are there and are they equally effective?

### Single-source approaches to RF shimming – Anatomy-specific & elliptical drive

Other concepts have been proposed to provide some form of shimming of the transmit  $B_1$  field [9, 23, 35, 36]. Figure 6a and 6b show two example arrangements. Both approaches use a single RF source with some downstream hardware splitting of the signal. The approach of Figure 6a utilizes a discrete hybrid switch (in the high power domain) which, instead of providing a fixed 90 degree phase delay and equal output amplitudes to both channels, allows a limited number of preset fixed amplitude and phase ratios to be selected to provide, for example, anatomy-specific drive of the 2 ports of the body coil [36, 37, 38]. However, the practical need to provide patient- adaptive RF shimming renders this approach inadequate.

Restricting the shim settings to a limited number based only on anatomy, is not adequate to ensure consistent image quality across different subjects. The architecture of Figure 6a also does not easily allow independent  $B_1$  maps to be obtained from each channel of the body coil and so it becomes virtually impossible to perform patient-adaptive RF shimming.

Figure 6b illustrates a similar approach except that the splitting of the single RF source is performed in the low-power domain before the RF amplifier. What characterizes and limits both approaches is the fact that they use a single RF source. This simple fact limits the available degrees of freedom to just 4 (independent amplitude and phase per port during transmission) compared with the 14 available in the Achieva 3.0T TX (see further). Such single-source approaches are commonly described as being equivalent to MultiTransmit. The details in this paper explain and illustrate why this is not the case.

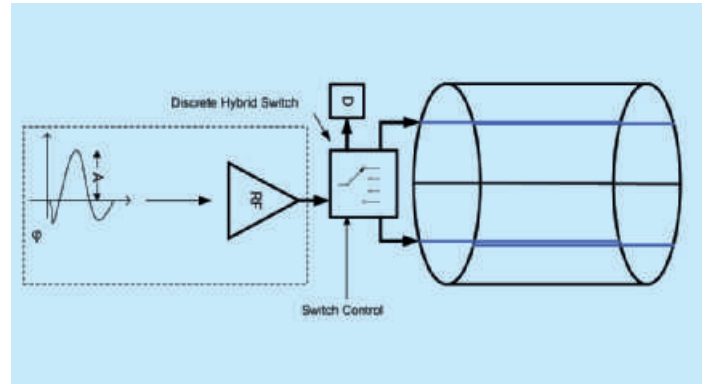

Figure 6a Elliptical drive body coil (high power) with single RF source.

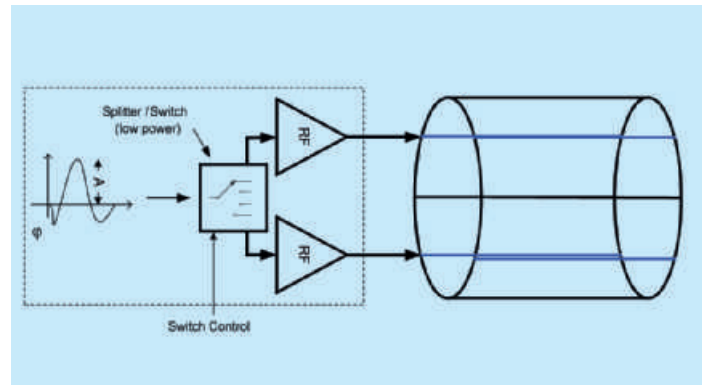

Figure 6b Elliptical drive integrated body coil (low power) with single RF source.

## Conclusion 2

There are a number of single-source approaches that are presented as alternative solutions to MultiTransmit.

These approaches are significantly restricted in performance and consistency due to the limited ways in which they can be adjusted because of their inherently fewer degrees of freedom.

## What are the benefits of MultiTransmit parallel RF transmission?

### Enhanced contrast uniformity

The benefits of MultiTransmit stem from the fundamental improvement in uniformity of the transmitted  $B_1$  field inside the patient, which largely eliminates dielectric shading. When the  $B_1$  field is uniform throughout the volume of interest then all spins receive close to the same flip angle. In most MR imaging methods, the contrast behavior

depends upon the flip angle and sequence timing. A more uniform  $B_1$  field results in a more uniform flip angle, leading in turn to more uniform contrast sensitivity within the volume of interest (see Figure 7). This is important in providing diagnostic confidence, especially in studies that perform any kind of quantification based upon contrast.

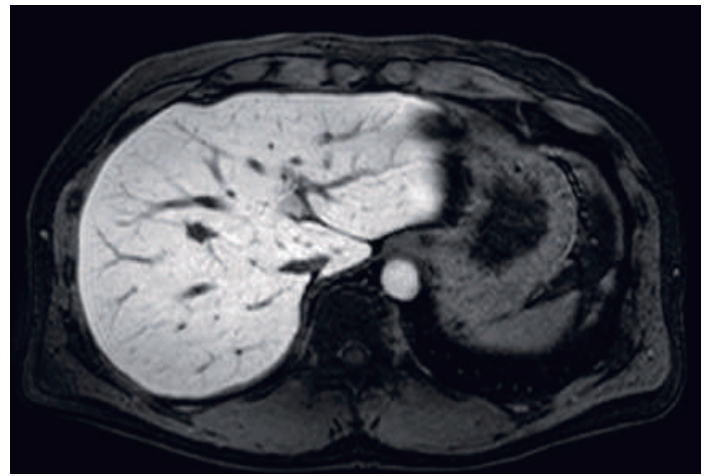
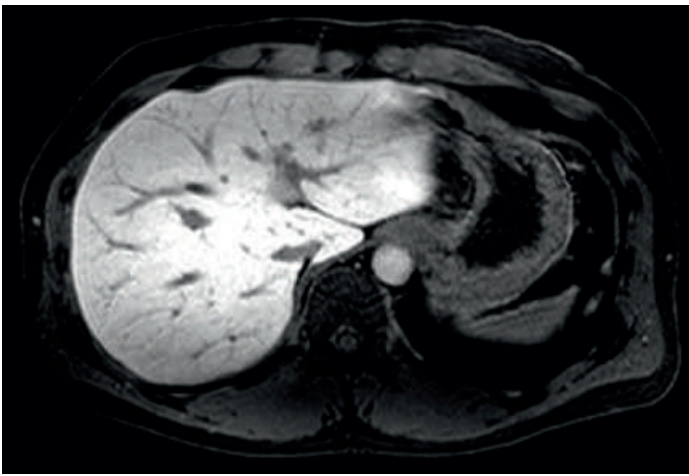

Conventional 3T

MultiTransmit

Figure 7 Enhanced contrast uniformity using MultiTransmit. 3D eTHRIVE T1W liver images. Left: conventional 3T with contrast variations due to dielectric shading. Right: MultiTransmit with enhanced contrast uniformity across the full FOV.

### Conclusion 3

MultiTransmit provides enhanced contrast uniformity.

## Enhanced image uniformity

The second benefit of MultiTransmit relates to the use of receive shimming. Due to the principle of reciprocity, the non-uniform transmit B1 field also results in non-uniform receive sensitivity. A common method of compensating general image non-uniformity in conventional high-field imaging systems is to use a post-processing normalization filter that derives an intensity correction function directly from the final image. These so-called “Bias Field Correction (BiFiC)” [24,25] image filters can produce a uniform image appearance but often require application-specific tuning.

A similar approach was introduced with the original Achieva 3.0T platform [26]. While providing a notable improvement in image uniformity, these approaches cannot compensate for the missing contrast and reduced SNR inevitable with non-uniform transmit and receive sensitivity.

The unique design of the Achieva 3.0T TX makes it possible to utilize the shimmed receive sensitivity of the body coil to also correct for non-uniform image intensity and SNR.

Figure 8 illustrates the benefits of shimming both the transmit field and the receive sensitivity. The conventional image set (Fig 8a) is typical of the image contrast and uniformity attainable on a conventional (single RF source) 3T system. There are regions of dielectric shading in which the signal and contrast have disappeared. Applying an image-based uniformity correction filter (Fig 8b) can improve the overall uniformity but does not compensate for the lost SNR and contrast. In the example of Fig 8c, MultiTransmit provides the best image uniformity, highest SNR and the highest-fidelity representation of contrast.

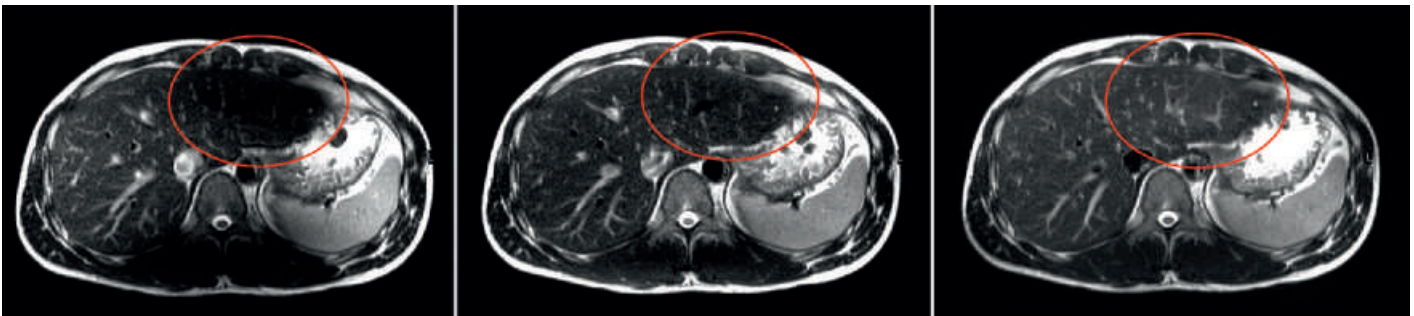

a) Conventional 3T

b) Conventional 3T + B<sub>1</sub> filter

c) MultiTransmit

Figure 8 The benefits of shimming both the transmit field and the receive sensitivity by a) conventional, single-transmit 3T, b) conventional, single-transmit 3T with B<sub>1</sub> filter, c) MultiTransmit. Note that MultiTransmit shows details not seen in conventional imaging (red circle).

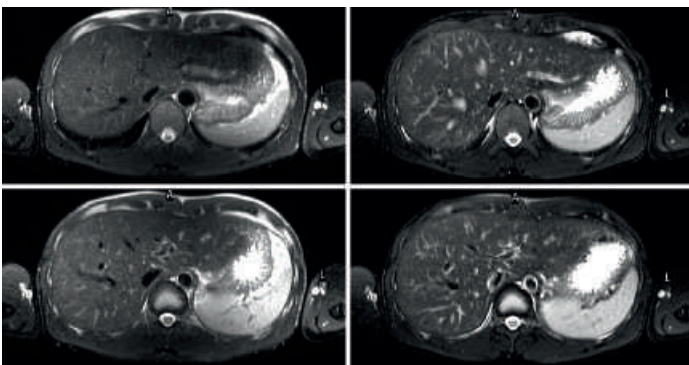

Conventional 3T

MultiTransmit

Figure 9 Enhanced contrast, signal uniformity and fat suppression.

Left: conventional 3T. Right: MultiTransmit.

As shown in Figure 9, an additional benefit of a more uniform B<sub>1</sub> transmit field is that spectral fat suppression is now more effective.

### Conclusion 4

MultiTransmit provides enhanced image uniformity and more robust fat suppression.

## Enhanced consistency

The use of patient-adaptive RF shimming ensures that optimum RF shimming is used for each patient. Optimum RF shimming precisely realizes the desired flip angle distribution within each patient. A consistent contrast and uniformity behavior is now possible, especially in areas most affected by dielectric shading, like body and breast.

Figure 10 shows 3 examples of breast imaging with fixed RF settings (single transmit) and patient-adaptive optimized RF settings using MultiTransmit. Although fixed settings can provide good signal uniformity in one patient (upper row), it fails to provide uniform contrast in other patients (middle, lower row). With MultiTransmit patient-adaptive RF, image uniformity can be obtained in all patients, thereby providing better consistency.

With MultiTransmit, enhanced consistency can be obtained patient after patient, which also leads to enhanced diagnostic confidence. In the example of Figure 11, fifteen consecutive breast patients were scanned with MultiTransmit. The result shows consistency in image quality (contrast, signal homogeneity, fat suppression) in all patients.

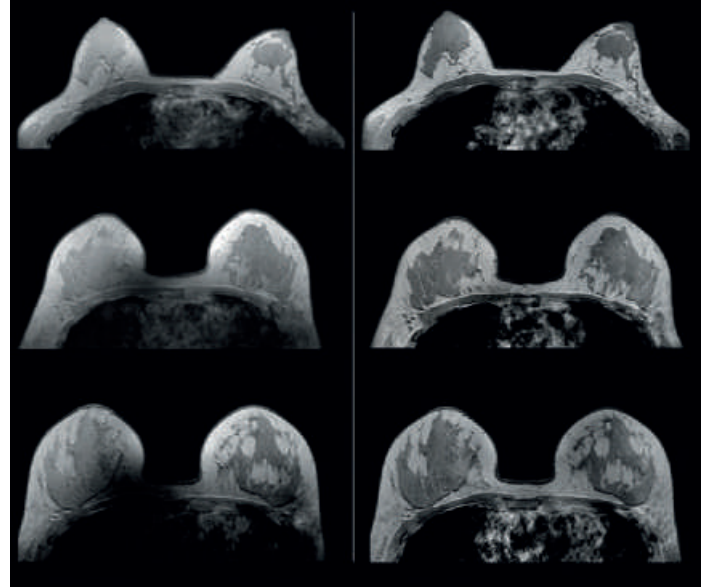

Conventional 3T

MultiTransmit

Figure 10 Three examples of breast imaging with fixed RF settings (left, single transmit) and patient-adaptive optimized RF settings using MultiTransmit (right).

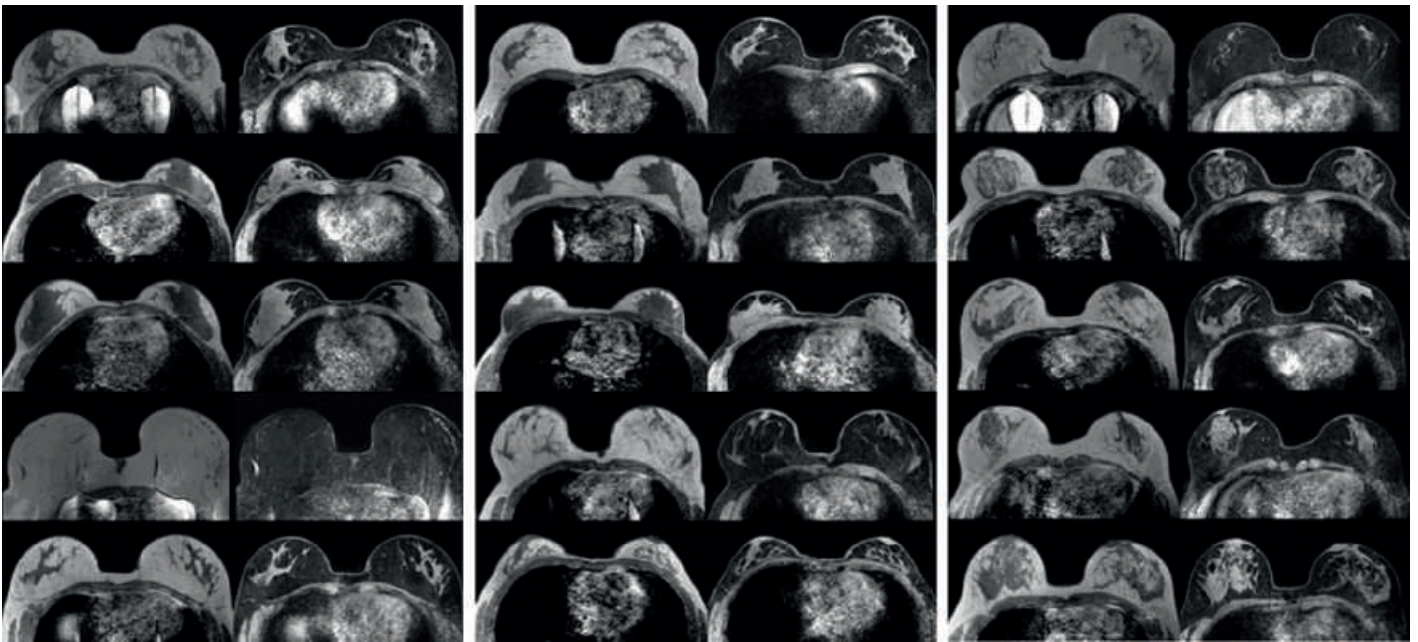

Figure 11 Consistency in 15 patients using MultiTransmit at 3.0T. Consistent image quality (signal and contrast uniformity) is attainable patient after patient.

### Conclusion 5

MultiTransmit provides enhanced consistency.



## Faster imaging – SAR and speed

### Why is faster imaging possible with MultiTransmit?

The use of MultiTransmit offers additional degrees of freedom that can be exploited to reduce SAR [16,19,21]. EM field simulations indicate that, for various anatomies, improved RF uniformity using RF shimming is also accompanied by reduced whole-body and/or local SAR [27,28].

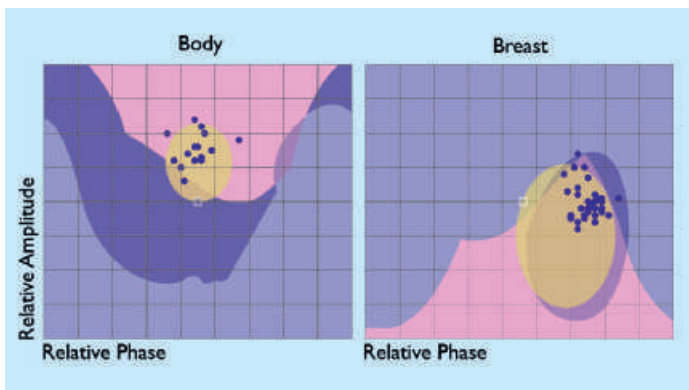

Figure 12 Better uniformity and reduced SAR

Figure 12 shows plots of the distribution of RF shim settings for two different anatomies. The horizontal axis of each plot represents the relative phase RF shim value and the vertical axis the relative amplitude RF shim value between the two RF sources used to drive the Achieva 3.0T TX body coil.

The plots are arranged such that the central point of each plot represents the RF shim settings for quadrature transmission. The RF shim settings for a number of human examinations are represented by the blue dots. EM simulations, using a number of 3D body models [27, 28], were used to determine the contours, as a function of RF shim settings, corresponding to various SAR limits (yellow, blue, dark blue). The simulations were also used to determine the contour representing the range of RF shim settings for improved  $B_1$  uniformity while maintaining practical power sensitivity (pink).

The yellow region represents the range of RF shim settings resulting in SAR levels lower than those expected for conventional (quadrature) transmission. The pink region indicates the range of shim settings resulting in  $B_1$  uniformity better than attainable with

quadrature transmission. Both in body and breast imaging, the actual shim settings determined for human examinations fall within the overlapping regions of improved  $B_1$  uniformity and reduced SAR. This illustrates that improved  $B_1$  uniformity is consistent with SAR levels lower than those attainable with quadrature transmission. And, of course, when SAR is reduced [27,28], it becomes possible to scan faster.

Additionally, conventional single-transmit RF hardware often assumes worst-case RF deposition. With MultiTransmit hardware, it has become possible to adapt the RF to each individual patient, and therefore optimize RF management, thus better accommodating speed increases in all RF intensive applications.

Figure 13 shows the enhanced uniformity and speed improvement using MultiTransmit in a spine TSE sequence.

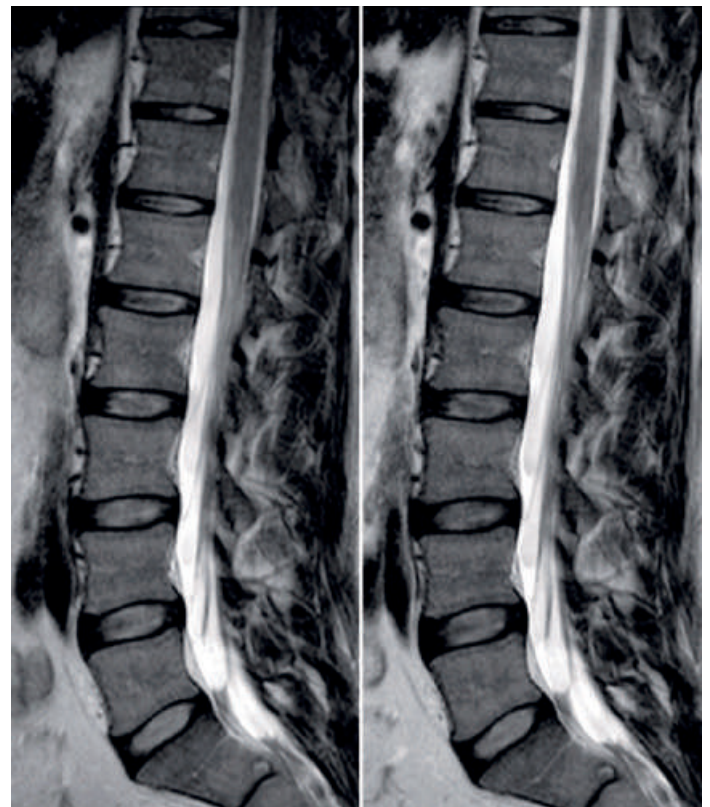

Conventional 3T MultiTransmit

Figure 13 Enhanced speed in T2W TSE of the lumbar spine. Left: conventional 3T, scan time 4:25 min. Right: MultiTransmit, scan time 2:23 min. Also note the enhanced contrast uniformity.

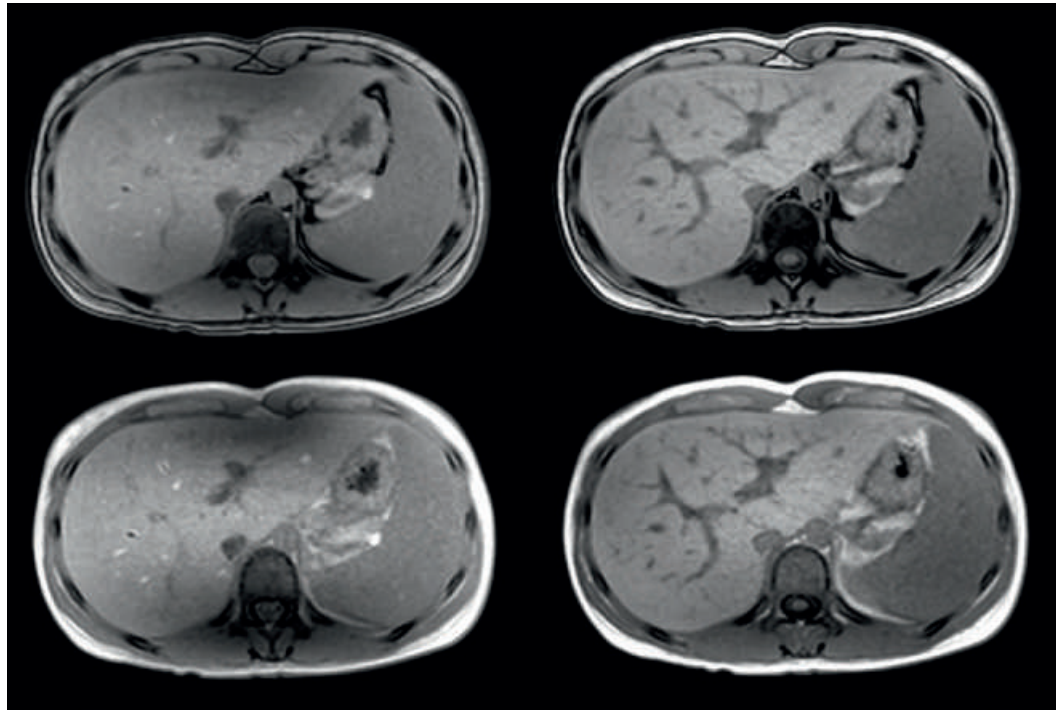

Conventional 3T

MultiTransmit

Figure 14 Enhanced speed with dual-echo (out/in-phase) T1W imaging of the liver. Left: conventional 3T, two breathholds (30 sec). Right: MultiTransmit, one breathhold (15 sec). Also note the enhanced contrast uniformity.

Figure 14 shows the benefit of speed improvement through the reduction in the number of breathholds in abdominal imaging.

#### **Conclusion 6**

MultiTransmit can reduce SAR and provide enhanced speed in RF intense applications.

# RF channels, RF sources, how many is really enough?

## How many independent RF sources are really needed in parallel RF transmission?

It is important to note the difference between channels and sources. See Table 1. A single RF source can feed multiple channels. However, the degrees of freedom depend on the number of RF sources, so it is more relevant to talk about the number of RF sources. Moreover, the important issue is not how many RF sources there are, but how they are used.

With the MultiTransmit architecture of the Achieva 3.0T TX, it is possible to use independent waveforms, phase offset, amplitude scaling and frequency offset during RF transmission (4 parameters per source). During reception, independent scaling, phase offset and frequency offset are also possible (3 parameters per channel). The total degrees of freedom for the MultiTransmit architecture are therefore  $8+6=14$ . With these many degrees of freedom we have demonstrated that the current implementation of MultiTransmit dramatically improves the quality of all clinical applications that suffer from dielectric shading. The quality level of image contrast and intensity uniformity achievable with MultiTransmit can now be considered as the new gold standard for 3.0T.

Philips and various researchers are exploring the benefits of increasing the number of RF sources. Philips' own development started with a MultiTransmit system built using 8 RF sources. Based on experience gained in-house, and with external research partners, Philips researchers established that two sources, when implemented with full flexibility and control, provide the largest proportion of dielectric shading correction that can be obtained. This observation has also been made by other developers in the field [8,9,23].

The additional benefits of using more than two RF sources is currently an area of intensive research activity. However, the improvement in dielectric shading obtainable using two sources is already so complete that the extra degrees of freedom available through using more RF sources would be better used for purposes other than RF shimming. The additional true clinical benefits of using more than two RF sources are therefore still to be defined and validated.

### Conclusion 7

With two independent RF sources at 3.0T there are 14 degrees of freedom to fully address dielectric shading and to enhance speed.

### Conclusion 8

The current MultiTransmit architecture fully addresses the most significant constraints on 3.0T clinical performance.

# MultiTransmit development

## What is the history of MultiTransmit?

Figure 15 shows the evolution of RF in 3T MRI. 1<sup>st</sup> and 2<sup>nd</sup> generation RF all use single-transmit systems with a single RF source. Starting with a single-transmit RF source, most manufacturers have implemented ways to optimize the RF, thereby optimizing for imaging each anatomy as much as possible (anatomy optimized). Philips developed RF-SMART for this purpose [30]. To fully address fundamental

challenges such as dielectric shading and SAR limitations, a breakthrough step was made by implementing parallel RF transmission using multiple, independent RF sources (3<sup>rd</sup> generation RF). Philips developed MultiTransmit for this purpose. Moreover, in the future we foresee that with this new generation, it will become possible to apply new methods and sequences, such as Transmit SENSE [20].

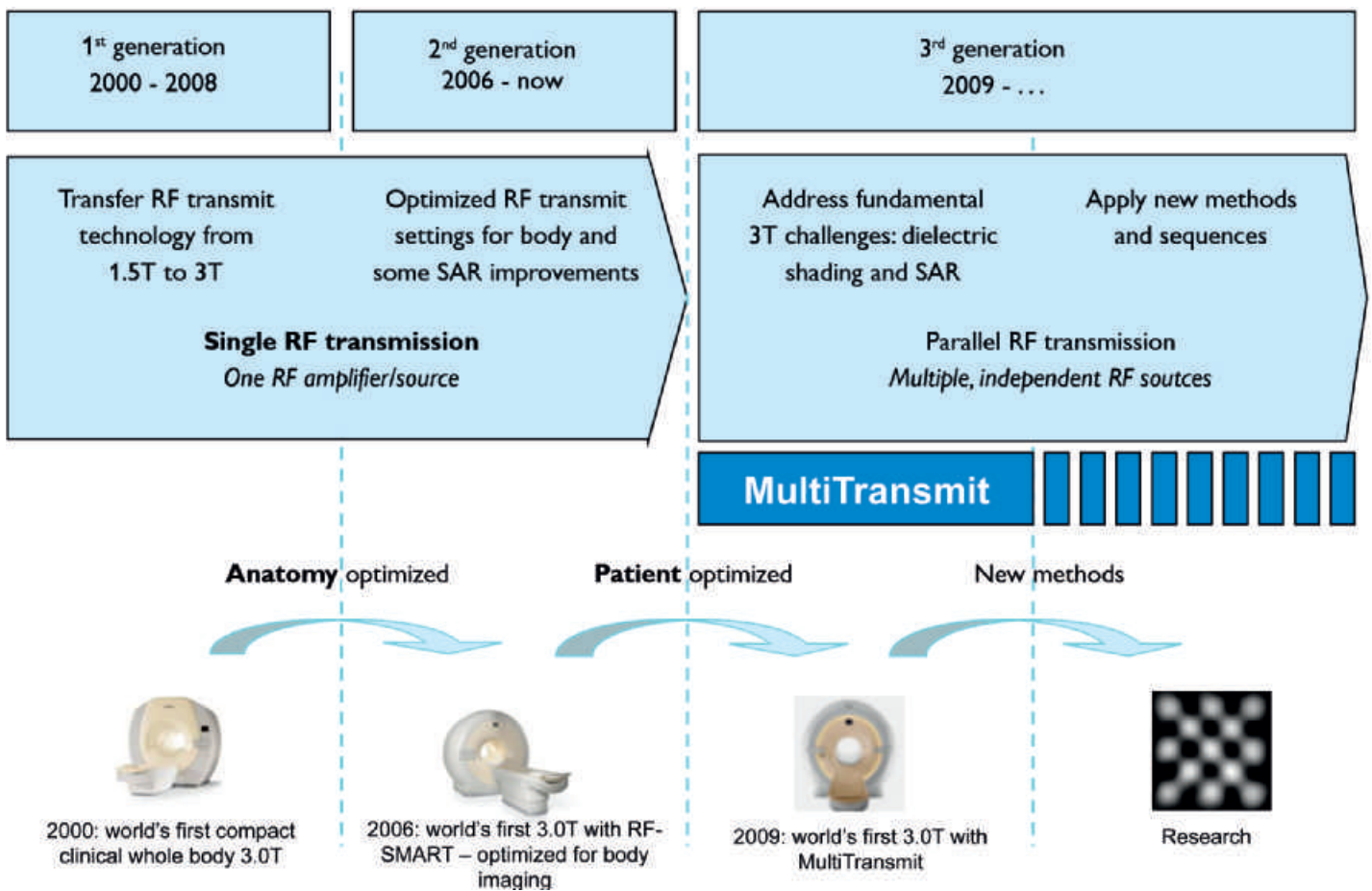

Figure 15 Evolution of RF in 3T systems. MultiTransmit is the first RF technology that uses patient-optimized RF settings to address fundamental 3T challenges. This is obtained by parallel RF transmission using multiple, independent RF sources.

Philips has been active in MultiTransmit development for more than 20 years, and many of the milestones in this field have been demonstrated first by Philips. Philips patents, submitted as far back as 1988, describe an RF coil that uses multiple independent elements, each driven by its own on-coil RF amplifier [29]. Philips researchers demonstrated one of the first examples of a degenerate birdcage RF coil that could be used for parallel reception and transmission on multiple channels [31]. This coil topology continues to form the basis

for parallel transmission research in various institutes [33]. Philips researchers were also the first to describe different MR methods, such as the concept of TransmitSENSE [20, 40] and also to demonstrate it using an experimental MultiTransmit clinical whole-body 3.0T system.

The architecture and potential benefits of the Achieva 3.0T TX were first described by Philips MRI development in 2003 [17].

#### **Conclusion 9**

Philips has been leading the research into parallel RF transmission since 1988.

#### **Conclusion 10**

The world's first MultiTransmit clinical MR system is the fruit of more than 20 years' exploration into parallel RF transmission by Philips.

*Courtesy:*

*We thank the University of Bonn - Germany,  
Tokai University - Japan and the University of Vermont - USA  
for providing clinical material.*

# References:

- [1] Kuhl C. et al., *Acute and Subacute Ischemic Stroke at High-Field-Strength (3.0T) Diffusion-weighted MR Imaging: Intraindividual Comparative Study*, Radiology 2005; 234:509–516
- [2] Hoenig K. et al., *Functional 3.0-T MR Assessment of Higher Cognitive Function: Are There Advantages over 1.5-T Imaging?*, Radiology 2005; 234:860–868
- [3] Manka C. et al., *Three-dimensional Dynamic Susceptibility-weighted Perfusion MR Imaging at 3.0 T: Feasibility and Contrast Agent Dose*, Radiology 2005; 234:869–877
- [4] Saupé N. et al., *MR Imaging of the Wrist: Comparison between 1.5- and 3-T MR Imaging - Preliminary Experience*, Radiology 2005; 234:256–264
- [5] Morakkabati N. et al., *MRI of the pelvis at 3 T: very high spatial resolution with sensitivity encoding and flip-angle sweep technique in clinically acceptable scan time*, Eur Radiol 2006 16: 634–641
- [6] Willinek, W. et al., *Time-of-Flight MR Angiography: Comparison of 3.0-T Imaging and 1.5-T Imaging—Initial Experience*, Radiology 2003; 229:913–920
- [7] Leiner T. et al., *Contrast-Enhanced Peripheral MR Angiography at 3.0 Tesla: Initial Experience With a Whole-Body Scanner in Healthy Volunteers*, J. Magn. Reson. Imaging 2003;17:609–614
- [8] Wiesinger F. et al., *Evaluation of parallel transmit RF-shimming performance for 3 tesla whole-body imaging*, Proc. ISMRM 2007, 3352
- [9] Nistler J. et al., *Homogeneity Improvement Using A 2 Port Birdcage Coil*, Proc. ISMRM 2007, 1063
- [10] Collins, C.M. et al., *Calculated Local and Average SAR in Comparison with Regulatory Limits*, Proc. ISMRM 2006, 2044
- [11] Wang, Z. et al., *SAR and temperature: Simulations and comparison to regulatory limits for MRI*, J. Magn. Res. Imag., 26, 2, 437-441, 2007
- [12] Nadobny, J. et al., *Evaluation of MR-induced hot spots for different temporal SAR modes using a time-dependent finite difference method with explicit temperature gradient treatment*, IEEE Trans Biomed Eng 54 (10) Oct 2007, 1837-1850
- [13] Merkle, E. M. et al., *Abdominal MRI at 3.0 T: the basics revisited*, Am. J. Roentgenol. 2006;186:1524-1532
- [14] Kuhl C.K. et al., *Effect of B1 inhomogeneity on breast MR imaging at 3.0 T [letter]*, Radiology, 2007, 244, 929-30
- [15] Geppert G. et al., *Reduced B1-inhomogeneities in breast MRI using optimized RF excitation*, Proc. ISMRM 2008, 2726
- [16] Graesslin I. et al., *Whole Body 3T MRI System with Eight Parallel RF Transmission Channels*, Proc. ISMRM 2006, 129
- [17] Harvey, P.R. et al., *Adjustment of RF-Field Homogeneity In High-Field MR Imaging*, Patent nr WO2006033047, 2004
- [18] IEC 60601-2-33, “*Medical Electrical Equipment and Particular Requirements for the Safety of Magnetic Resonance Equipments for Medical Diagnosis and Protection Against Hazardous Output*”, Internat. Electrotech. Commis., 2002
- [19] Van den Berg C.A.T. et al., *Simultaneous B+1 Homogenization and Specific Absorption Rate Hotspot Suppression Using a Magnetic Resonance Phased Array Transmit Coil*, Magn Reson Med 57:577–586, 2007
- [20] Katscher, U. et al., *Transmit SENSE*, Magn. Reson. Med., Vol 49, Issue 1, 144-150, 2003
- [21] Zhu, Y., *Parallel excitation with an array of transmit coils*, Magn. Reson. Med., Vol. 51, 775-784, 2004

- [22] Glover G.H. et al., *Comparison of Linear and Circular Polarization for Magnetic Resonance Imaging*, J. Magn. Reson. 64, pp. 255-270, 1985
- [23] Mckinnon. et al., *RF Shimming and SAR Considerations with an Eight-Element 3T Body Coil*, Proc. ISMRM 2007, 1085
- [24] Jellúš V. et al., *New Modification of the Homomorphic Filter for Bias Field Correction*. Proc. ISMRM 2005, 2247
- [25] Lichy M. P. et al., *Image quality improvement of composed whole-spine MR images by applying a modified homomorphic filter—first results in cases of multiple myeloma*, Eur Radiol 2008 18: 2274–2282
- [26] Fuderer M. et al., *Intensity correction at high field MRI by filtering of the reference scan*, Proc. ISMRM 2004, 2145
- [27] Harvey, P.R. et. al, *SAR Behavior During Whole-Body MultiTransmit RF Shimming at 3.0T*, Proc. ISMRM 2009, 4786
- [28] Zhai Z. et al., *A Study of the Relationship between B1-field Uniformity, Body Aspect Ratio and SAR for Whole-Body RF Shimming at 3.0T*, Proc. ISMRM 2009, 3045
- [29] Mens, W.R.M. et al., *Magnetic Resonance Apparatus having An Improved RF Coil*, US Patent US4952878 (1989 - 1990)
- [30] Harvey, P.R., *High Field Imaging – An Overview of Technical Challenges*, Weekend Syllabus, MR Physics For Physicists – Day 2, *Overview of Technical Challenges*, Proc. ISMRM 2006
- [31] C. Leussler et al., *The bandpass birdcage resonator modified as a coil array for simultaneous MR acquisition*, in: Proc ISMRM 2008, 176
- [32] C. Leussler, *Transmission and Receiving Coil for MR Apparatus*, Patent no WO02095435, 2001
- [33] Alagappan V. et al., *Degenerate Mode Band-Pass Birdcage Coil for Accelerated Parallel Excitation*, Magn. Reson. Med. 57:1148–1158, 2007
- [34] Harvey, P.R. et al., *New X-series technology drives 3.0T into the clinical domain*, 2007, Philips Healthcare
- [35] *Siemens Magnetom World*, Issue 40, 2009
- [36] Zhai, Z. et al., *MR Involving High Speed Coil Mode Switching Between I-Channel Linear, Q-Channel Linear, Quadrature And Anti-Quadrature Modes*, Patent no WO2007124246, 2006
- [37] McKinnon et al., *System and Method Of Elliptically Driving An MRI Coil*, Patent No. US7135864, 2005
- [38] Nistler et al., *Method For Controlling a Magnetic Resonance System*, Patent No. US20080284432, 2008
- [39] Cecil E. Hayes, et al., *An Efficient, Highly Homogeneous Radiofrequency Coil for Whole-Body NMR Imaging at 1.5 T*, Journal of Magnetic Resonance 63, 622-628, 1985
- [40] Katscher, U. et al., *Parallel RF transmission in MRI*, NMR in Biomedicine, 19: 393-400, 2006

**Philips Healthcare is part of  
Royal Philips Electronics**

**How to reach us**

[www.philips.com/healthcare](http://www.philips.com/healthcare)

[healthcare@philips.com](mailto:healthcare@philips.com)

fax: +31 40 27 64 887

**Asia**

+852 2821 5888

**Europe, Middle East, Africa**

+49 7031 463 2254

**Latin America**

+55 11 2125 0744

**North America**

+1 425 487 7000

800 285 5585 (toll free, US only)

**Philips Healthcare**

Global Information Center

P.O. Box 1286

5602 BG Eindhoven

The Netherlands

Please visit [www.philips.com/achievatx](http://www.philips.com/achievatx)



© 2009 Koninklijke Philips Electronics N.V.  
All rights are reserved.

Philips Healthcare reserves the right to make changes in specifications and/or to discontinue any product at any time without notice or obligation and will not be liable for any consequences resulting from the use of this publication.

Printed in The Netherlands.  
4522 962 52861 \*AUG 2009